



This quick start guide briefly describes some of the common setup procedures for this meter. The Guide describes how to use the front panel buttons and DProM software to program and setup the meter. We recommend the following sequence as the easiest method for getting the meter into service:

- Connect DProM Software (with no other connections) and program the meter.
- Install the meter.
- Make input, output and power connections.
- Make any programming adjustments with the front panel buttons.

For additional information about this meter not covered in this quick start guide, please consult the instruction manual available at www.ashcroft.com.

Front Panel Buttons Operation

Button Symbol	Description
	Menu: Press the Menu button to enter or exit the Programming Mode at any time.
	Right Arrow: Press the Right arrow button to move to the next digit during digit or decimal point programming.
	Up Arrow: Press or hold the Up arrow button to scroll through the menus, decimal point, or to increment the value of a digit.
	Enter: Press the Enter button to access a menu or to accept a setting.

Safety Information

CAUTION

- Read complete instructions prior to installation and operation of the meter.

WARNINGS

- Risk of electric shock or personal injury. Hazardous voltages exist within enclosure.
- Installation and service should be performed only by trained service personnel.
- This product is not recommended for life support applications or applications where malfunctioning could result in personal injury or property loss. Anyone using this product for such applications does so at their own risk. Ashcroft, Inc. shall not be held liable for damages resulting from such improper use.

Installation

There is no need to remove the meter from its case to complete the installation, wiring, and setup of the meter for most applications. Instructions are provided for changing the transmitter power supply to output 5 or 10 VDC instead of 24 VDC.

Panel Mounting Instructions

- Prepare a standard 1/8 DIN panel cutout - 3.622" x 1.772" (92 mm x 45 mm). Refer to Figure 1. 1/8 DIN Panel Cutout Dimensions below for more details.
- Clearance: allow at least 6.0" (152 mm) behind the panel for wiring.
- Panel thickness: 0.04" - 0.25" (1.0 mm - 6.4 mm). Recommended minimum panel thickness to maintain Type 4X rating: 0.06" (1.5 mm) steel panel, 0.16" (4.1 mm) plastic panel.
- Remove the two mounting brackets provided with the meter (back-off the two screws so that there is 1/4" (6.4 mm) or less through the bracket. Slide the bracket toward the front of the case and remove).
- Insert meter into the panel cutout.
- Install mounting brackets and tighten the screws against the panel. To achieve a proper seal, tighten the mounting bracket screws evenly until meter is snug to the panel along its short side. **DO NOT OVER TIGHTEN**, as the rear of the panel may be damaged.

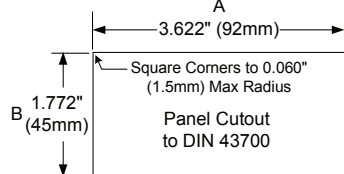

Tolerances:
 A: +0.032 (+0.8mm)
 -0.000 (-0.0mm)
 B: +0.024 (+0.6mm)
 -0.000 (-0.0mm)

Figure 1. 1/8 DIN Panel Cutout Dimensions

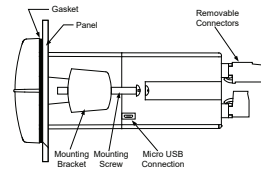

DO NOT apply AC or DC power to the meter when using the Micro USB connection.

Figure 2. Panel Mounting Details

Mounting Dimensions

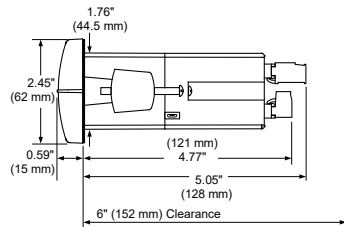

Figure 3. Meter Dimensions - Side View

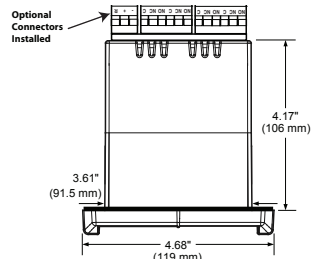

Figure 4. Meter Dimensions - Top View

Connections

All connections are made to removable screw terminal connectors located at the rear of the meter. These accept wire between 12 to 24 AWG.

CAUTION

- Use copper wire with 60°C or 60/75°C insulation for all line voltage connections. Observe all safety regulations. Electrical wiring should be performed in accordance with all applicable national, state, and local codes to prevent damage to the meter and ensure personnel safety.

WARNING

- **DO NOT** connect any equipment other than Ashcroft's expansion modules, cables, or meters to the RJ45 M-LINK connector. Otherwise damage will occur to the equipment and the meter.

Connectors Labeling

The connectors' label, affixed to the meter, shows the location of all connectors available with requested configuration.

Note: # on the following figures refers to the power options. (Example: DM61-D-AC)

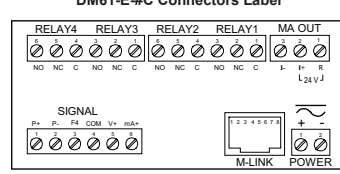
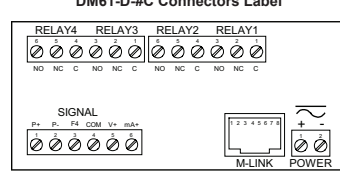
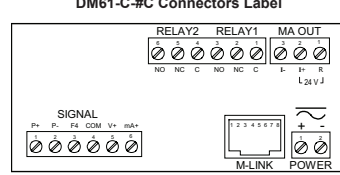
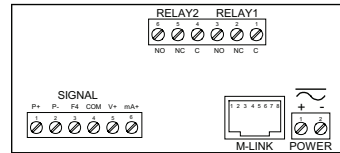
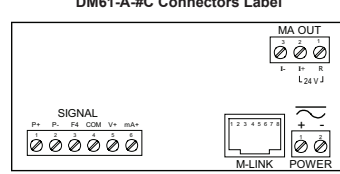
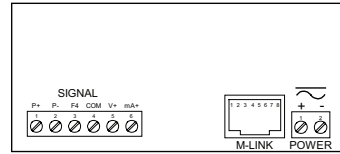

Power Connection

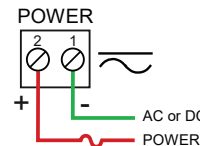

- Notes:
1. "AC" Powered meters accept 85-265 VAC or 90-265 VDC and "DC" powered meters accept 12-24 VDC/VAC
 2. Required External Fuse: 5A max, Slow Blow.
 3. Consult the DM61 instruction manual located at www.ashcroft.com for additional wiring diagrams.

Signal Connections

The connectors label, affixed to the top of the meter, shows the location of all available connectors. Connect your wires to the provided connectors and plug into the meter as indicated.

4-20 mA Input Wiring

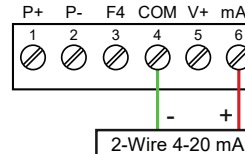
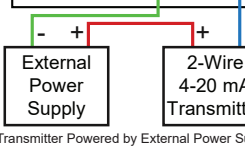
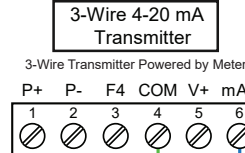
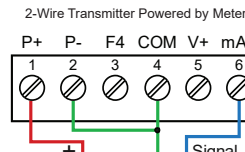
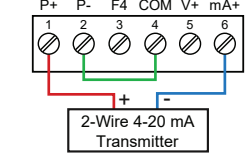

0-10 V Input Wiring

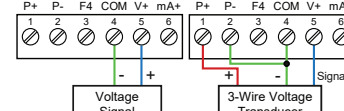

F4 Digital Input Connection

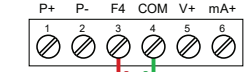

4-20 mA Output Wiring¹

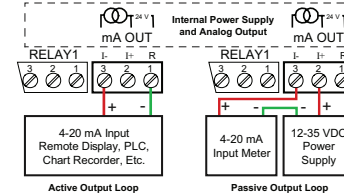

Relay Connections²

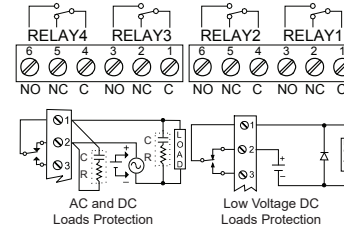

- ¹DM61 models with 4-20 mA output option
²DM61 models with relay option

Main Menu

The main menu consists of the most commonly used functions: Setup, Reset, Control, and Password.

- Press Menu button to enter Programming Mode then press the Up arrow button to scroll main menu.
- Press Menu, at any time, to exit and return to Run Mode. Changes made to settings prior to pressing Enter are not saved.
- Changes to the settings are saved to memory only after pressing Enter/F3.
- The display moves to the next menu every time a setting is accepted by pressing Enter/F3.

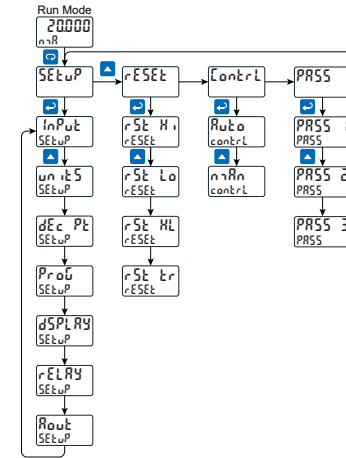

Transmitter Supply Voltage Selection (P+, P-)

All meters, including models equipped with the 12-24 VDC power option, are shipped from the factory configured to provide 24 VDC power for the transmitter or sensor.

If the transmitter requires 5 or 10 VDC excitation, the internal jumper J4 must be configured accordingly.

To access the voltage selection jumper:

1. Remove all the wiring connectors.
2. Unscrew the back cover.
3. Slide out the back cover by about 1 inch.
4. Configure the J4 jumper, located behind the input signal connector, for the desired excitation voltage as shown.

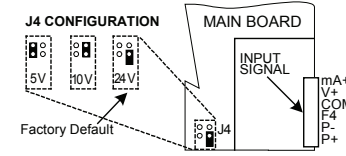

Program and Scale the Input

These instructions illustrate how to program the DM61 to accept a 4-20 mA or 0-10 VDC input and scale it to display the desired range. When the input to the meter is 4 mA or 0 V, it displays the low end of the programmed display range. When the input is 20 mA or 10 V, it displays the high end of the programmed display range. The input values (InP 1 & InP 2) can be changed if needed, but the steps to do this have been omitted for this quick start guide.

For example: If the DM61 is used to display the volume of a 10,000 gallon tank, the pressure transducer should send a 4 mA signal when the tank is empty and a 20 mA signal when the tank is full. The DM61 should be configured to interpret these inputs on a display range of 0.0-10,000.0, so that at 4 mA the meter will display 0.0 and at 20 mA the meter will display 10,000.0.

IMPORTANT

- **Reverse Scaling**
 The meter can be scaled so that 4 mA represents the high end of the process value range being measured by the transmitter and 20 mA represents the low end of the process value range.

DProM Software

1. On the Setup tab, under Input Type, select the desired input.

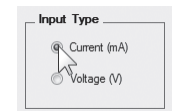

2. On the Programming tab, select the desired decimal point location.

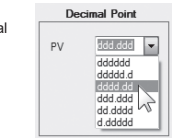

3. Under Scale Values, enter the desired low and high display values in the Display column.

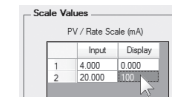

4. Click the Send Meter Data button to send your programmed settings to the meter.

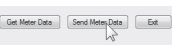

Meter Configuration Menus

1. Press to enter Programming Mode, press to access the SEtUP (Setup) menu.



2. Press to access the InPUt SEtUP (Input) menu.



3. Press to select either mA or Voltage (n:n or Vol:t) and press to accept the input type.



4. Press to access the d-SCAL (Dual Scale) menu, press to select SE5 or n:n, then press .



Note: Most applications only require one scale (select no).

5. The units menu is displayed. Press to skip and go to the dec Pt menu.



Note: See page 2 for un:t5 menu.

6. Press to access the dEc Pt (Decimal Point) menu.



7. Press until the desired decimal point location is displayed and press to accept.



8. Press to access the ProG (Program) menu.



9. Press to access the SCAL E (Scale) menu.



10. Press three times, until d.5 1 (Low Display Value) is displayed. Use to change which digit is selected and to increment the selected digit. Press when done.



11. Press three times, until d.5 2 (High Display Value) is displayed. Use to change which digit is selected and to increment the selected digit. Press when done. Press to return to Run Mode.

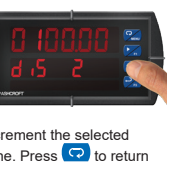

Setting the Display Parameter & Intensity

To access the Display (dSPLY) menu press the Menu button and then Enter when Setup (SEtUP) appears. Press the Up Arrow until dSPLY appears and then follow the menu tree below.

- The main display (Line 1) can be programmed to display:
- Process value 1 (PV1)
 - Process value 2 (PV2)*
 - Percent of PV1 (PCT)*
 - Relay set points
 - Max & min values
 - Modbus input
 - Display reading and units
 - Display gross
 - Toggle net & gross

- The secondary display (Line 2) can be programmed to display:
- Unit
 - Process value 1 (PV1)
 - Process value 2 (PV2)*
 - Percent of PV1 (PCT)*
 - Relay set points
 - Max & min values
 - Engineering units or custom legends
 - Modbus input
 - Off (no display)
 - Toggle reading and units
 - Display gross
 - Toggle net/gross

*These menu items will only appear if Dual-Scale feature is turned on.

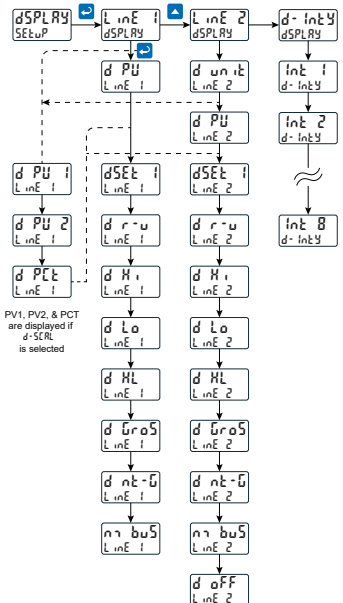

Display Intensity (d-Int)
The meter has eight display intensity levels to give the best performance under various lighting conditions. Select intensity 8 for outdoor applications. The default intensity is 6.

Dual-Scale Display Feature
The dual-scale feature is of particular value in level applications where a second scaled display can represent the measured input in a different form (i.e. gallons & height). Both displays are independently scaled and are based on the 4-20 mA input signal.

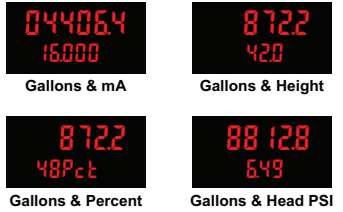

Program Custom Unit Tags

The DM61 meter may be programmed to display custom unit tags for the process value. Display line 2 shows this custom unit tag by default.

Note: The custom unit tag has no bearing on the meter's operation or the process value. Displaying a custom unit tag is simply for ease of reading.

DProM Software

1 On the Setup tab, in the Display section, enter your desired units designation in the Units field. This field is limited to six characters. The letters 'm' and 'w' count as two because they require two LEDs.

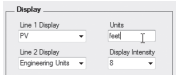

Note: Delete existing text in Units field before entering new text.

2 Click the Send Meter Data button to send your programmed settings to the meter.

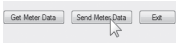

Meter Configuration Menus

1 Press [Enter] to enter Programming Mode, press [Menu] to access the SEtUP (Setup) menu.



2 Press [Up] until the Units (Units) menu is displayed and then press [Enter] to access.



3 The meter will display the default unit tag (nR). Notice here that the letter 'm' uses two 7 segment LEDs. This is true of the letter 'w' as well.



4 Use [Right] to change which letter is selected and [Up] to increment to the next letter. Press [Enter] when done to accept the new custom unit tag.



Program Relays

The relays on the DM61 meter can be programmed to operate in the following manner:

- Automatic (non-latching) and/or manual reset
- Latching (requires manual acknowledge) with or without clear
- Pump alternation control (2-8 relays)
- Sampling (based on set point and time)
- Off (disable unused relays and enable Interlock feature)
- Manual on/off control mode

The relays can be reset in the following manner:

- User selectable via front panel button
- F4 terminal at back of meter
- External contact closure on digital inputs, or through serial communications

Each relay is controlled by a set point and a reset point and may be programmed to trip on an increasing signal (High) or decreasing signal (Low) in the following manner:

- High trip point: program set point above reset point.
- Low trip point: program set point below reset point.

The deadband is determined by the difference between set and reset points. Minimum deadband is one display count. If the set and reset points are programmed with the same value, the relay will reset one count below the set point.

On and Off time delays may be programmed for each relay between 0 and 999.9 seconds. The relays will transfer only after the condition has been maintained for the corresponding time delay. The On time delay is associated with the set point. The Off time delay is associated with the reset point.

The following illustrates how to program the meter for Automatic Reset:

DProM Software

1 On the Relays tab, in the desired relay section, select "Auto" from the Action drop down list.

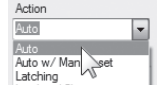

2 Enter the set and reset point values in the provided fields.

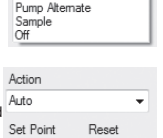

3 Click the Send Meter Data button to send your programmed settings to the meter.

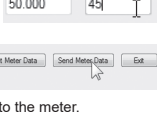

Note: All four relays (if installed) are programmed in this manner. It is not necessary to send your programmed settings to the meter after each relay is programmed, simply repeat steps 1 & 2 for each relay then send to the meter.

Meter Configuration Menus

1 Press [Enter] to enter Programming Mode, press [Menu] to access the SEtUP (Setup) menu.



2 Press [Up] until the rELAY (Relay) menu is displayed and then press [Enter] to access.



3 Press [Up] until the appropriate relay number is displayed (rLY 1-8) and then press [Enter] to access.



4 Press [Enter] to access the Rct (Relay Action) menu.



5 Press [Enter] to accept Rct (Automatic Reset).



6 Press [Enter] to access the SEt (Relay Set Point) menu.



7 Use [Right] to change which digit is selected and [Up] to increment the selected digit. Press [Enter] when done to accept the new set point value.



8 Press [Enter] to access the rSt (Relay Reset Point) menu.



9 Use [Right] to change which digit is selected and [Up] to increment the selected digit. Press [Enter] when done to accept the new set point value. Press [Enter] to return to Run Mode.



Note: Use [Left] to select a different relay during step 3. If you need to program more relays, simply repeat steps 3-9 for each additional relay. Consult the DM61 Instruction Manual for information on additional relay action types.

Program 4-20 mA Analog Output

The source for generating the 4-20 mA output may be assigned to the process variable, maximum or minimum value reached by the rate/process, or one of the set points, or the Modbus PV input.

The 4-20 mA analog output may be scaled to provide a 4-20 mA signal for any display range selected. No equipment is needed to scale the analog output; simply program the display values to the corresponding mA output signal. The Analog Output menu is used to program the 4-20 mA output.

The display values programmed for the 4-20 analog output do not need to be the same as those programmed for input scale values, though they typically are.

The 4-20 mA output can be reversed scaled such that, for example, 4 mA corresponds to 100 and 20 mA corresponds to 0.

DProM Software

1 On the Setup tab, under Analog Out Scale, enter your desired display values in the provided fields.

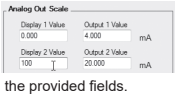

2 Click the Send Meter Data button to send your programmed settings to the meter.

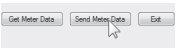

Meter Configuration Menus

1 Press [Enter] to enter Programming Mode, press [Menu] to access the SEtUP (Setup) menu.



2 Press [Up] until the Rout (Analog Out) menu is displayed and then press [Enter] to access.



3 Press [Enter] to access the dS 1 (Display 1) menu. This is the display value at which the low range of the output will be transmitted.



4 Use [Right] to change which digit is selected and [Up] to increment the selected digit. Press [Enter] when done to accept the new display value.



5 Press [Enter] to access the Out 1 (Output 1) menu. This is the output signal which represents dS 1.



6 The default value of 04000 (4.000 mA) should work for most applications. Press [Enter] to accept.



7 Press [Enter] to access the dS 2 (Display 2) menu. This is the display value at which the high range of the output will be transmitted.



8 Use [Right] to change which digit is selected and [Up] to increment the digit. Press [Enter] when done.



9 Press [Enter] to access the Out 2 (Output 2) menu. This is the output signal which represents dS 2.



10 The default value of 20000 (20.000 mA) should work for most applications. Press [Enter] to accept the default value.



Advanced Features Menu

For features and capabilities not commonly used during setup, see the complete instruction manual found at www.ashcroft.com for details on the Advanced Features menu.

Setting Up the Password

The Password menu is used for programming three levels of security to prevent unauthorized changes to the programmed parameter settings.

Pass 1: Allows use of function keys and digital inputs

Pass 2: Allows use of function keys, digital inputs and editing set/reset points

Pass 3: Restricts all programming, function keys, and digital inputs.

Protecting or Locking the Meter

Enter the Password menu to program a six-digit password.

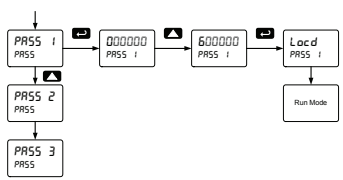

Return Meter to Factory Defaults

If a mistake has been made while programming the meter and it is unclear where the error occurred, the best option may be to perform a factory reset of the meter and begin again.

DProM Software

1 On the Advanced Features tab, in the bottom left-hand corner, click the Reset Meter Factory Defaults button.

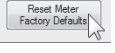

2 In the confirmation window that appears, click OK. The meter will reset to factory defaults.



Meter Configuration Menus

1 Press and hold [Enter] for five seconds to enter the Advanced Features menu.



2 Press [Up] until the dRG (diagnostics) menu is displayed.



3 Press and hold [Right] until the meter flashes rSEt (reset). Immediately press [Enter] to reset the meter.



4 The meter will go blank and reboot, and then display ProcES (Process).



Compliance Information Safety

UL & C-UL Listed	USA & Canada UL 508 Industrial Control Equipment
UL File Number	E358533
Front Panel	UL Type 4X, NEMA 4X, IP65; panel gasket provided
Low Voltage Directive	EN 61010-1 Safety requirements for measurement, control, and laboratory use

Electromagnetic Compatibility

Emissions	EN 55022 Class A ITE emissions requirements
Radiated Emissions	Class A
AC Mains Conducted Emissions	Class A
Immunity	EN 61326-1 Measurement, control, and laboratory equipment EN 61000-6-2 EMC heavy industrial generic immunity standard
RFI - Amplitude Modulated	80 - 1000 MHz 10 V/m 80% AM (1 kHz) 1.4 - 2.0 GHz 3 V/m 80% AM (1 kHz) 2.0 - 2.7 GHz 1 V/m 80% AM (1 kHz)
Electrical Fast Transients	±2kV AC mains, ±1kV other
Electrostatic Discharge	±4kV contact, ±8kV air
RFI - Conducted	10V, 0.15-80 MHz, 1kHz 80% AM
AC Surge	±2kV Common, ±1kV Differential
Surge	1kV (CM)
Power-Frequency Magnetic Field	30 A/m 70%V for 0.5 period
Voltage Dips	40%V for 5 & 50 periods 70%V for 25 periods
Voltage Interruptions	<5%V for 250 periods

Note: Testing was conducted on meters installed through the covers of grounded metal enclosures with cable shields grounded at the point of entry representing installations designed to optimize EMC performance.

EU Declaration of Conformity

For shipments to the EU and UK, a Declaration of Conformity was printed and included with the product.

Troubleshooting Tips

This meter is a highly sophisticated instrument with an extensive list of features and capabilities. If the front panel buttons are used to program the meter, it may be a difficult task to keep everything straight. That is why we strongly recommend the use of the free DProM software for all programming activities. A cable is provided with the meter for programming with DProM software.

Symptom	Check/Action
No display at all	Check power at power connector
Not able to change setup or programming. Loc'd is displayed	Meter is password-protected, enter correct six-digit password to unlock
Meter does not respond to input change	If a Low-Flow Cutoff Value has been programmed, the meter will display zero below that point, regardless of the input - which can appear like the meter is not responding to an input change. Check to make sure the problem is not being caused by an undesired low-flow cutoff value.
Meter displays error message during calibration (Error)	Check: 1. Signal connections 2. Input selected in Setup menu 3. Minimum input span requirements
Meter displays 1. 99999 2. -99999	Check: 1. Input selected in Setup menu 2. Corresponding signal at Signal connector
Display is unstable	Check: 1. Input signal stability and value 2. Display scaling vs. input signal 3. Filter and bypass values (increase)
Display response is too slow	Check filter and bypass values
Display reading is not accurate	Check: 1. Input signal conditioner selected. Linear, square root, etc. 2. Scaling or calibration
Display does not respond to input changes, reading a fixed number	Check: 1. Display assignment, it might be displaying max, min, or set point.
Display alternates between 1. H + and a number 2. L o and a number	Press Menu to exit max/min display readings.
Relay operation is reversed	Check: 1. Fail-safe in Setup menu 2. Wiring of relay contacts
Relay and status LED do not respond to signal	Check: 1. Relay action in Setup menu 2. Set and reset points
Flashing relay status LEDs	Relays in manual control mode or relay interlock switches opened.
Meter not communicating with application programs	Check: 1. Serial adapter and cable 2. Serial settings 3. Meter address and baud rate
If the display locks up or the meter does not respond at all	Cycle the power to reboot the microprocessor.
Other symptoms not described above	Call Technical Support for assistance.

Limited Warranty

Ashcroft, Inc. warrants this product against defects in material or workmanship for the specified period as detailed in the "Specifications" section of the complete manual from the date of shipment from the factory. Ashcroft's liability under this limited warranty shall not exceed the purchase value, repair, or replacement of the defective unit. See Warranty Information and Terms & Conditions on www.ashcroft.com for complete details.

Software Version 4.010 & Up

Ashcroft Inc.
250 East Main Street, Stratford, CT 06614 USA
Tel: 203-378-8281, Fax: 203-385-0402
www.ashcroft.com
All sales subject to standard terms and conditions of sale. © 2023 Ashcroft Inc. 2023 QSG - 02/23