

Custom Made to Your Specifications

# RTD and Thermocouple Temperature Probes



# Welcome to Ashcroft

**Ashcroft® offers a full line of pressure  
and temperature instruments.**

At Ashcroft, we believe you should spend more time focused on your business, and less on your pressure and temperature measurements. That's why we offer a variety of high-quality, reliable measurement instruments that can be found in locations such as processing facilities, power plants and chemical reactors throughout the world.

Whether your application is for light-industrial temperature measurements or critical heavy-duty installations deep within your system, you deserve to feel confident in your temperature measurements.

Ashcroft's solutions include resistance temperature detectors (RTDs) and thermocouple probes (TC) that are custom configured to meet your requirements, attachment methods, terminal heads with a variety of thermowells to protect your sensing elements and much more.



**Let us help you get reliable pressure and  
temperature measurements for your process.**

**Contact us today!**

 1.800.328.8258

 [ashcroft.com](http://ashcroft.com)

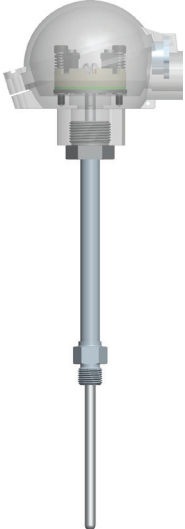
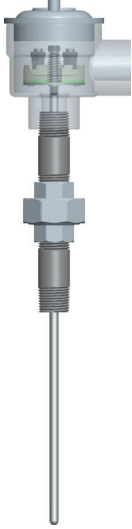
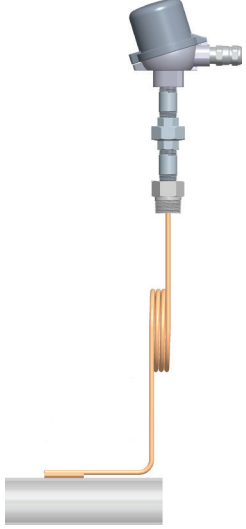
# Table of Contents

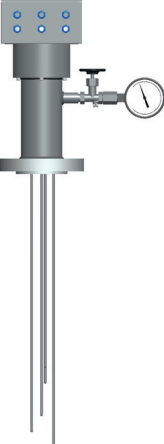
S01 RTD & Thermocouple DIN Inserts	S10 RTD & Thermocouple Probes with Metric Connections	S50 RTD & Thermocouple Probes with NPT Connections	S70 Probes with Tube Skin Connections
			
Thermocouple Types: J, K, T, E, N	Thermocouple Types: J, K, T, E, N	Thermocouple Types: J, K, T, E, N	Thermocouple Types: J, K, N
RTDs: 100 or 1000 Ohm, 2, 3, or 4 wire	RTDs: 100 or 1000 Ohm, 2, 3, or 4 wire	RTDs: 100 or 1000 Ohm, 2, 3, or 4 wire	RTDs: Available on request
<a href="#">PAGE 4</a>	<a href="#">PAGE 5</a>	<a href="#">PAGE 6</a>	<a href="#">PAGE 8</a>
S80 & S81 Probes with Extension Cable	S40 & S41 Thermocouple Probes for High Temperature Applications	S96 Multipoint Temperature Assemblies	Thermowells
			
S80 Thermocouple Probe: Thermocouple Types: J, K, T, E, N	S40 Common Metal Sensor up to 1200 °C: <a href="#">PAGE 11</a>	Straight or Flexible Assemblies	Flanged, Threaded, Weld-in or Van Stone Thermowells
S81 RTD Probe RTDs: 100 or 1000 Ohm 2, 3, or 4 wire	S41 Precious Metal Sensor up to 1800 °C: <a href="#">PAGE 12</a>	Lengths up to 300 m (1,000 ft)	
<a href="#">PAGE 10</a>	S41-04 Precious Metal Sensor with Sapphire Inserts up to 2000 °C: <a href="#">PAGE 13</a>	<a href="#">PAGE 14</a>	<a href="#">PAGE 15</a>

## S01 Industrial Temperature Sensor Insert

Inserts (RTDs and thermocouple types J, K, T, E and N) with mineral insulation, DIN mounting plate with ceramic terminal block with or without transmitter. Typically used for probe replacements.

### Applications

- For mounting in thermowells
- Inserts may also be mounted in direct contact with the medium, on condition that the electrical terminal block is protected against environmental
- Designs for intrinsically safe and non-incendive applications with FM, ATEX, and IECEx approvals

### Description

The sensors incorporated in all these inserts are protected by a metal sheath. They can be of two types: resistance temperature detectors (RTDs) or thermocouples (TCs). In each case, the sensor supplies an electrical signal corresponding to the temperature. The connection head carries a ceramic terminal block for connecting the wires, attached by two screws with springs. The travel of this spring mounting assures best thermal conductivity, compensation of length tolerances in thermowells and protection against vibration.

When mounted in thermowells, sensors can be simply replaced, without removing the thermowell from the pipe and without any process interruption.



**Ceramic terminal block or transmitter :**

Size DIN B  
Diam. 42 mm  
Screw spring : 33 mm  
Screw thread : M4 x 1.5  
Spring travel : 8 to 10 mm

Insert RTD or TC  
with transmitter

Insert TC with  
Flying Leads &  
Mounting Plate

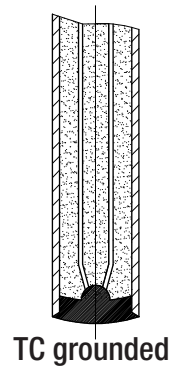
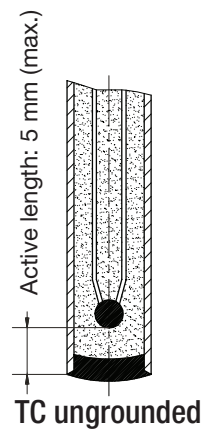
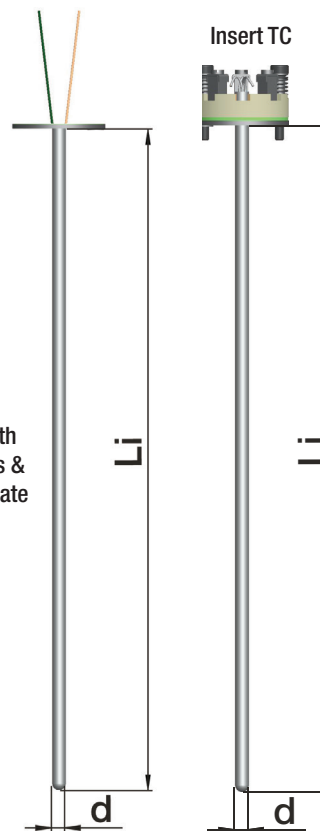
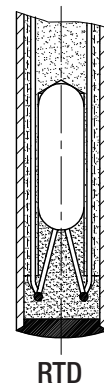

# S10 Industrial RTD & Thermocouples with Metric Connections

RTDs and thermocouple types J, K, T, E and N, inserts with mineral insulation, DIN mounting plate with/without lag extension according to DIN 43772.

## Applications

- For mounting on pipes, vessels, etc. already fitted with thermowells
- The bore diameter of the thermowell should be 0.5 to 1 mm greater than the insert diameter
- Designs for intrinsically safe and non-incendive applications with FM, ATEX, and IECEx approvals



## User Industries

- Oil & Gas
- Chemical, petrochemical
- Power generation

## Description

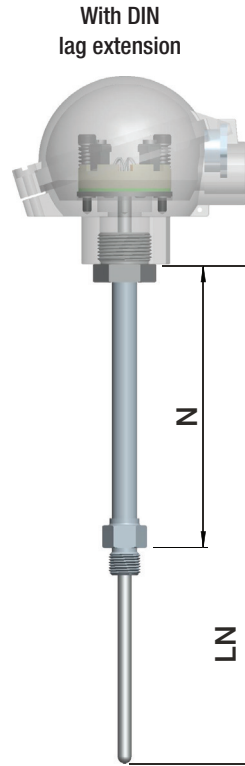
These probes may be fitted with one or two resistance temperature detectors (RTDs) or thermocouples (TCs). Each probe consists of a temperature sensor (insert), a connection head and a lag extension, with standardized process connection, with or without compression fitting.

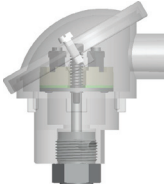
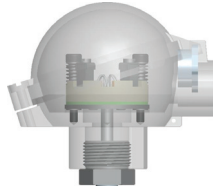

S10 HEADS	
DIN B - AL, grey	BUZ - AL, grey
	
BUZH - AL, grey	BBK - PA, black-yellow lid
	

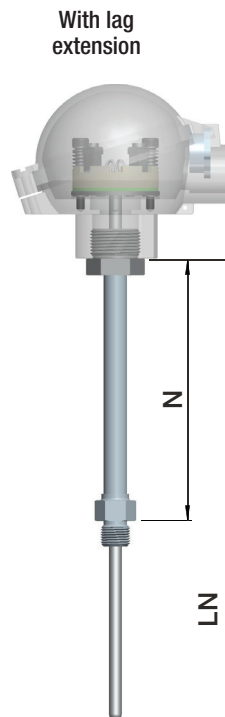

Without lag extension

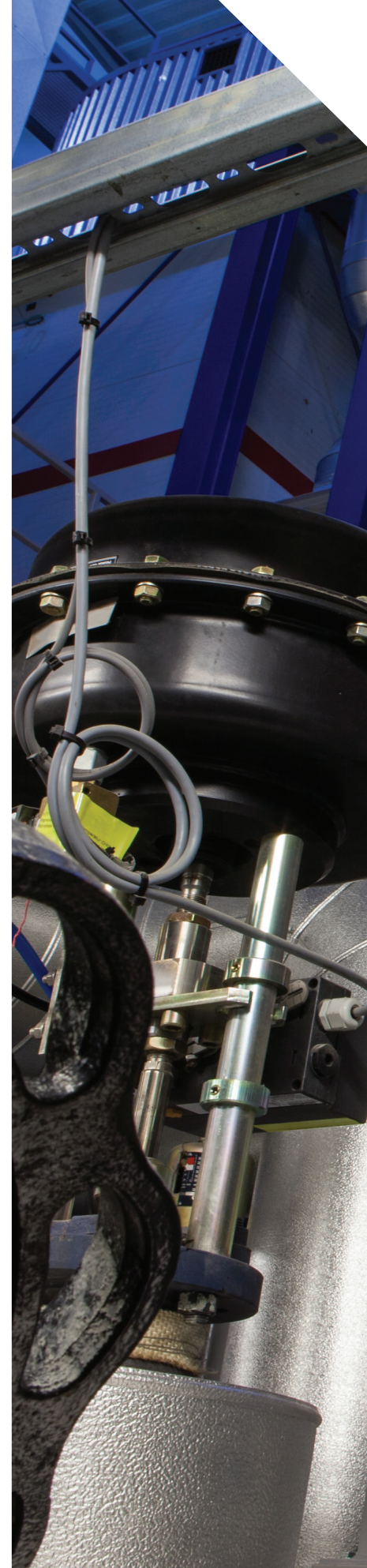

## S50 Industrial RTD & Thermocouples with NPT Connections

RTDs and thermocouple types J, K, T, E and N, inserts with mineral insulation, with or without lag extension according to ISA-dS 49.

### Applications

- For mounting on pipes, vessels, with process thermowells
- The bore diameter of the thermowell should be 0.5 to 1 mm greater than the insert diameter; bore depth and connections shall comply with ISA-dS 49 standard
- Designs for intrinsically safe, non-incendive and explosion proof applications with FM, ATEX, and IECEx approvals
- Available with DIN mounting plate or spring-loaded mounting

### User Industries

- Oil & Gas
- Chemical, petrochemical
- Power generation
- Water, wastewater

### Description

These probes may be fitted with one or two resistance temperature detectors (RTDs) or thermocouples (TCs). Each probe consists of a temperature sensor (insert), a connection head, a lag extension and a standardized process connection with or without compression fitting.

#### S50 HEADS

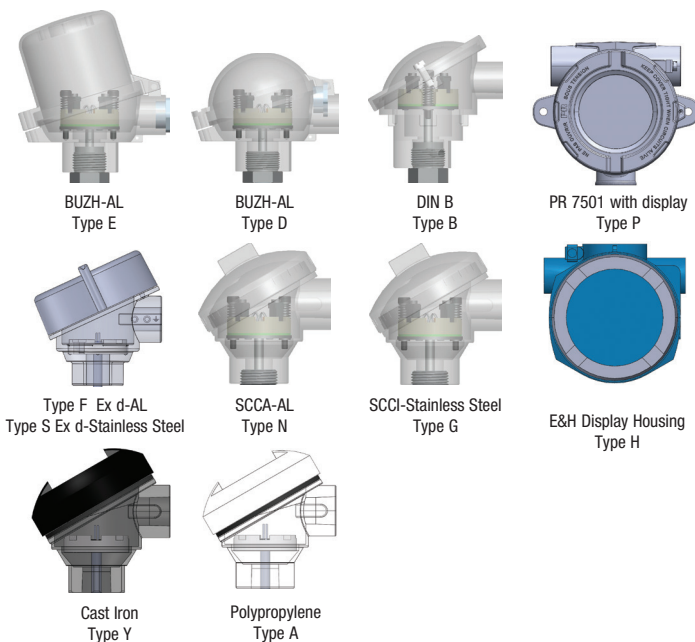

Nipple-Union  
Nipple-extension

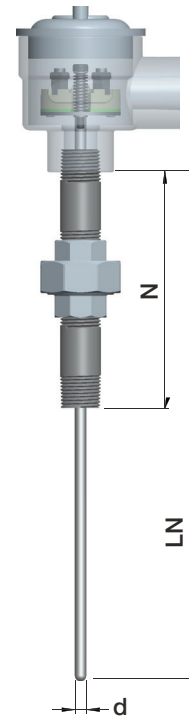

Without lag extension

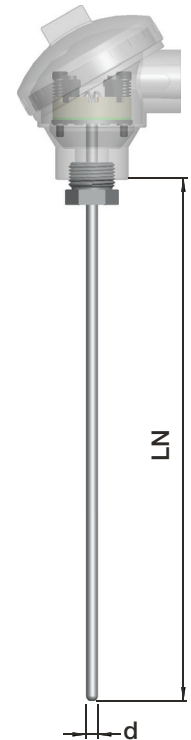

With transmitter and display

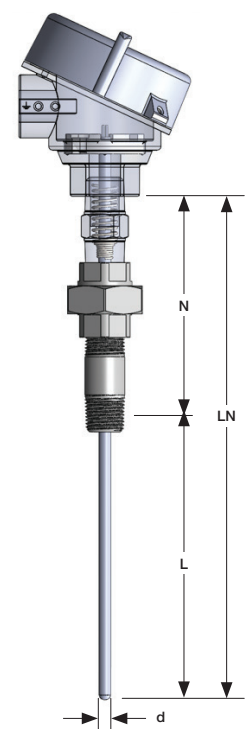
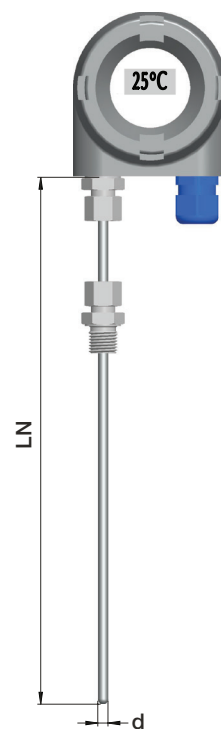

## SPECIFICATIONS FOR S01, S10, S50

### Sheath Diameter:

1/8", 1/4", 3 mm, 4.5 mm, 6 mm, 8 mm

### Sheath Length:

Minimum: 0.05 m (2 in.)

Maximum: 3 m (120 in.)

### Sensor Type & Measuring Range:

#### RTDs

Pt 100 -200 to 600 °C

Pt 1000 -40 to 600 °C

#### Thermocouples

Type J -400 to 750 °C

Type E -200 to 800 °C

Type K -200 to 1000 °C

Type N -200 to 1000 °C

Type T -250 to 350 °C

#### Wiring Configuration

##### RTDs Platinum 385

2 wire

3 wire

4 wire

##### Thermocouple

Single or Dual

### Accuracy Class:

RTDs (IEC 60751)

Class A:  $\pm(0.15 + 0.0020 \text{ t})$

Class B:  $\pm(0.30 + 0.0050 \text{ t})$

Class AA:  $\pm(0.10 + 0.0017 \text{ t})$

#### Thermocouples (ANSI MC 96.1)

	Type J	Type K	Type E	Type N	Type T
Standard	$\pm 2.2 \text{ °C}$ or $\pm 0.0075 \text{ °t}^{(1)}$	$\pm 2.2 \text{ °C}$ or $\pm 0.0075 \text{ °t}^{(1)}$	$\pm 1.7 \text{ °C}$ or $\pm 0.0050 \text{ °t}^{(1)}$	$\pm 2.2 \text{ °C}$ or $\pm 0.0040 \text{ °t}^{(1)}$	$\pm 1.0 \text{ °C}$ or $\pm 0.0075 \text{ °t}^{(1)}$
Special	$\pm 1.1 \text{ °C}$ or $\pm 0.0040 \text{ °t}^{(1)}$	$\pm 1.1 \text{ °C}$ or $\pm 0.0040 \text{ °t}^{(1)}$	$\pm 1.0 \text{ °C}$ or $\pm 0.0075 \text{ °t}^{(1)}$	$\pm 1.1 \text{ °C}$ or $\pm 0.0040 \text{ °t}^{(1)}$	$\pm 0.5 \text{ °C}$ or $\pm 0.0040 \text{ °t}^{(1)}$

(1) Absolute temperature in °C

#### Thermocouples (IEC 60584-2)

	Type J	Type K	Type E	Type N	Type T
Class 1	$\pm 1.5 \text{ °C}$ or $\pm 0.0040 \text{ °t}^{(1)}$	$\pm 1.5 \text{ °C}$ or $\pm 0.0040 \text{ °t}^{(1)}$	$\pm 1.5 \text{ °C}$ or $\pm 0.0040 \text{ °t}^{(1)}$	$\pm 1.5 \text{ °C}$ or $\pm 0.0040 \text{ °t}^{(1)}$	$\pm 0.5 \text{ °C}$ or $\pm 0.0040 \text{ °t}^{(1)}$
Class 2	$\pm 2.5 \text{ °C}$ or $\pm 0.0075 \text{ °t}^{(1)}$	$\pm 2.5 \text{ °C}$ or $\pm 0.0075 \text{ °t}^{(1)}$	$\pm 2.5 \text{ °C}$ or $\pm 0.0075 \text{ °t}^{(1)}$	$\pm 2.5 \text{ °C}$ or $\pm 0.0040 \text{ °t}^{(1)}$	$\pm 1.0 \text{ °C}$ or $\pm 0.0075 \text{ °t}^{(1)}$
Class 3	N/A	$\pm 2.5 \text{ °C}$ or $\pm 0.0040 \text{ °t}^{(1)}$	$\pm 2.5 \text{ °C}$ or $\pm 0.0150 \text{ °t}^{(1)}$	$\pm 2.5 \text{ °C}$ or $\pm 0.0150 \text{ °t}^{(1)}$	$\pm 1.0 \text{ °C}$ or $\pm 0.0150 \text{ °t}^{(1)}$

(1) Absolute temperature in °C



## S70 Tube Skin Thermocouples

Thermocouple types J, K and N for monitoring process temperature without the use of a thermowell. Skin type sensors accurately and reliably measure the temperature of a surface that the process media is in contact with without ever coming into contact with the media.

### Applications

- Surface temperature measurement on steam pipes, inside or outside vessels and reactors
- Temperature measurement on walls or flat surfaces
- Designs for intrinsically safe, non-incendive and explosion proof applications with FM, ATEX, and IECEx approvals

### User Industries

- Oil & Gas
- Chemical, petrochemical
- Power generation
- Fired heaters, boilers, reactor vessel wall

### Description

These probes are provided with a single thermocouple sensor, placed inside a flexible metal sheath. With connection head, with or without lag extension, process connection on request. Sealing if necessary, by a compression fitting on the sheathed cable. The expansion loops of the sheathed cable serve to compensate the dimensional changes due to thermal expansion between the measuring point and the process connection. They also protect against a cable failure due to vibration and capture hot spots with washer thermocouples.

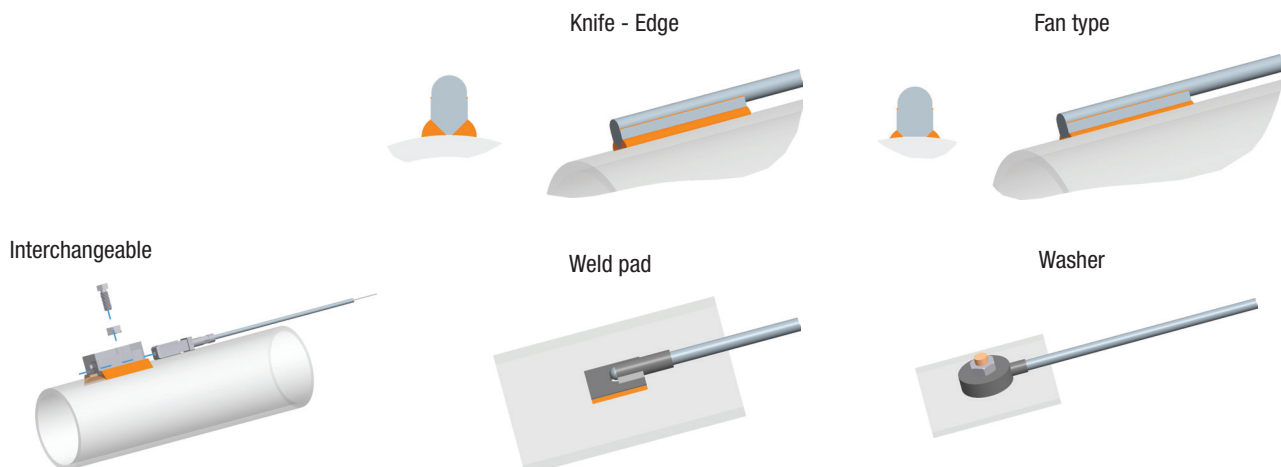
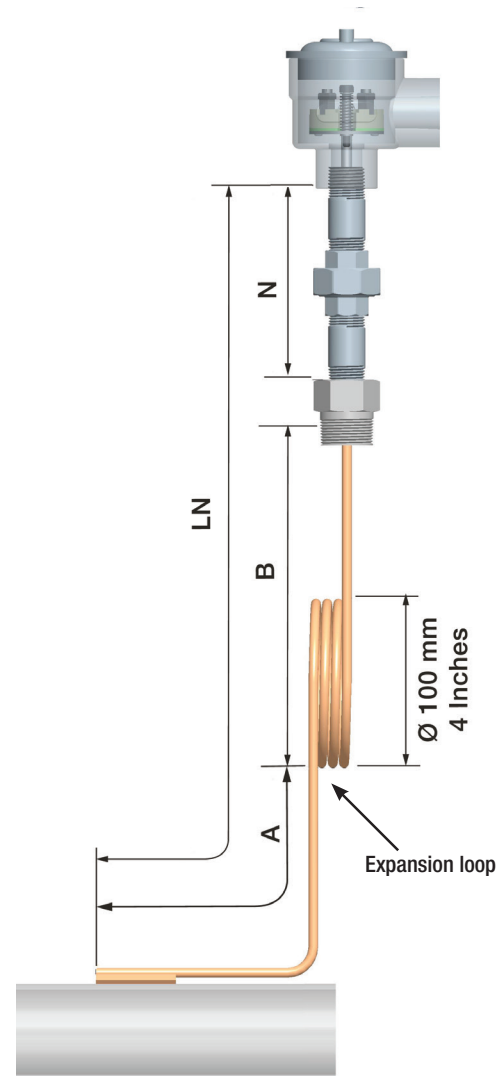





## SPECIFICATIONS FOR S70

<b>Insert Stem Diameter:</b>
1/4", 3/8", 1/2", 6 mm, 8 mm
<b>Stem Length:</b>
Maximum: 100 m (328 ft.)
<b>Sensor Type &amp; Measuring Range:</b>
Type J -40 to 750 °C
Type K -200 to 1000 °C
Type N -200 to 1000 °C
<b>Wiring Configuration:</b>
2 wire
<b>Accuracy Class:</b>
Standard limits of error
Special limits of error
(IEC 60584-2)
Class 1
Class 2
Class 3
(ANSI MC 96.1)
<b>Mounting:</b>
Knife-edge
Fan type
Washer
Interchangeable
Weld pad
Interchangeable with heat shield

### Thermocouples (ANSI MC 96.1)

	Type J	Type K	Type N
Standard	±2.2 °C or ±0.0075* t (1)	±2.2 °C or ±0.0075* t (1)	±2.2 °C or ±0.0040* t (1)
Special	±1.1 °C or ±0.0040* t (1)	±1.1 °C or ±0.0040* t (1)	±1.1 °C or ±0.0040* t (1)

(1) Absolute temperature in °C

### Thermocouples (IEC 60584-2)

	Type J	Type K	Type N
Class 1	±1.5 °C or ±0.0040* t (1)	±1.5 °C or ±0.0040* t (1)	±1.5 °C or ±0.0040* t (1)
Class 2	±2.5 °C or ±0.0075* t (1)	±2.5 °C or ±0.0075* t (1)	±2.5 °C or ±0.0075* t (1)
Class 3	N/A	±1.5 °C or ±0.0040* t (1)	±1.5 °C or ±0.0150* t (1)

(1) Absolute temperature in °C

## S80 Thermocouple & S81 RTD Probes

RTD and thermocouple types J, K, T, E and N temperature probes with mineral insulation, with or without extension cables, with wires terminations or connectors.

### Applications

- Flexible small size probes for machines, chemical plants, etc.
- For low-pressure, low-speed fluids and measurements requiring short response time
- For a wide range of media: vapors, gases, liquids and non-abrasive substances, provided that these are compatible with the sheath material
- May also be fixed on solid surfaces or inserted into cavities
- Designs for intrinsically safe and non-incendive applications with FM, ATEX, and IECEx approvals
- Available with remote heads and flex armor

### Description

These probes may be supplied with either one or two sensors. The sensor(s) is (are) placed inside a flexible metal sheath, with or without extension cable and process connection on request. If fitted, the extension cable (with or without protective spring and/or electromagnetic shielding) can be provided with PVC, silicone, PTFE or fiberglass insulation. The soldering between the extension cable and the sheathed cable is enclosed in a sleeve.

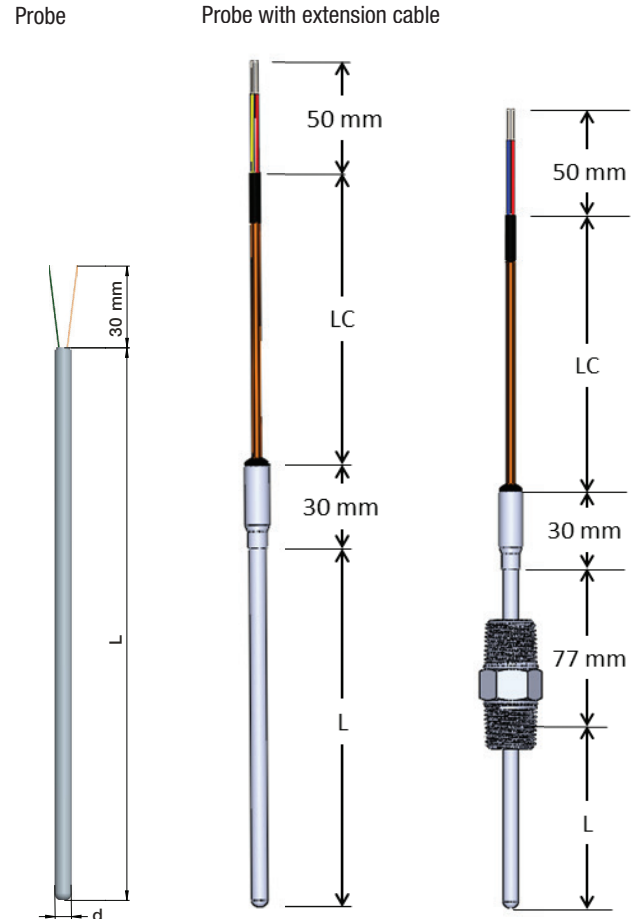

Round pin



Connector

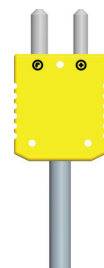

Protection spring



Compression fitting

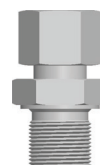

# S40 Common Metal Sensors

Thermocouple probe types J, K or N, for temperatures up to 1200 °C, with common metal sensors in ceramic inserts, and with protection tubes in metal (AMK, AM) or in ceramic (AK) according to DIN EN 50446.

## Applications

- Industrial ovens (heat treatment, incineration)
- Power engineering, reactors
- Chimneys (combustion gases)
- Annealing and heat treatment process
- Fusion baths for metal and glass
- Special designs for intrinsically safe and non-incendive applications with FM, ATEX, and IECEx approvals

## Description

These probes are designed especially for measurement of temperatures up to 1200 °C, but under low pressures only (high pressure available on request). They comprise a ceramic or metal thermowell (in contact with the medium), which houses a ceramic insert containing either one or two thermocouple sensors in common metal. Each probe also comprises a process connection (adjustable flange or welded flange) and a connection head. The inserts can be replaced without removing the thermowell (provided this is undamaged) and without any process interruption.

Three types of protection tubes are available:

AM = Metal protection tubes

AMK = Protection tubes consisting of a metal outer tube and ceramic inner tube

AK = Protection tubes consisting of one ceramic tube and a metal process connection tube

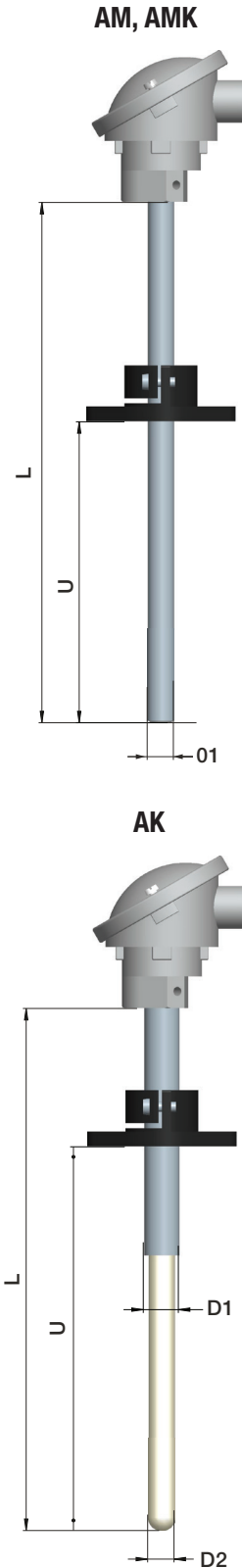
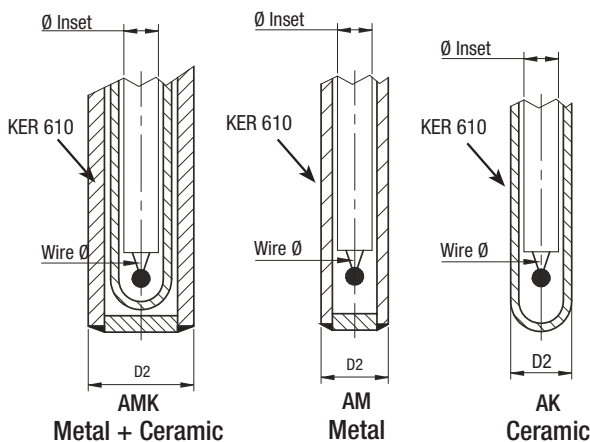

## S41 Precious Metal Sensor

Thermocouple probe types R, S or B for temperatures up to 1800 °C, with precious metal sensors in ceramic inserts, and with ceramic protection tubes (AKK, AK) according to DIN EN 50446.

### Applications

- Industrial ovens (heat treatment, incineration)
- Power engineering, reactors
- Combustion gases
- Annealing and heat treatment process
- Fusion baths for metal and glass
- Special designs for intrinsically safe and non-incendive applications with FM, ATEX, and IECEx approvals

### Description

These probes are designed especially for measurement of temperatures up to 1800 °C, but under low pressures only (high pressure available on request). They comprise a ceramic thermowell (in contact with the medium), which houses a ceramic insert containing either one or two thermocouple sensor(s) in precious metal. Each probe also comprises a process connection (adjustable flange or welded flange) and a connection head. The inserts can be replaced without removing the protection tubes (provided this is undamaged) and without any process interruption.

Two types of protection tubes are available:

AK = Protection tubes consisting of one single ceramic tube and a metal process connection tube

AKK = Protection tubes consisting of two ceramic tubes and a metal process connection tube

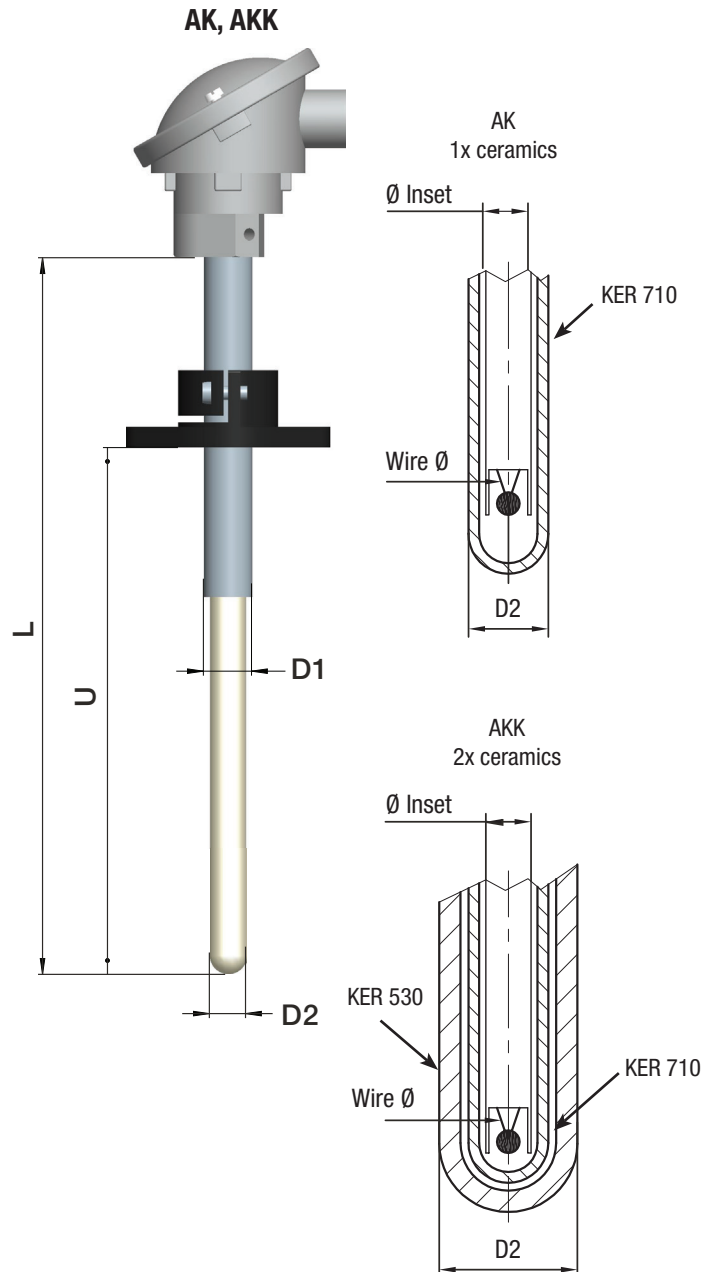

# S41-04 Precious Metal or Refractor Metal Sensors

Thermocouple probe type R, S, B or C for temperatures up to 2000 °C, with precious or refractory metal probes in ceramic or sapphire inserts, and with single-crystal sapphire protection tubes.

## Applications

- Industrial ovens (heat treatment, incineration)
- Power engineering, reactors
- Chimneys (combustion gases)
- Annealing and heat treatment process
- Fusion baths for metal and glass
- Reactor vessels/tanks
- Special designs for intrinsically safe and non-incendive applications with FM, ATEX, and IECEx approvals

## Description

These probes are specially designed for both high temperatures up to 2000 °C, and high pressures up to 200 bar. The thermowell is made from single-crystal sapphire. The insert is made from ceramics or sapphire and contains one or several thermocouple probes made of precious or refractory metals. It is possible to position the measurement points along several locations along the protection tubes to create a multi-point probe. Each probe comprises a process connection (adjustable flange or welded flange) as well as a connection head. As the sapphire thermowell is absolutely gas-tight, it is possible to replace the inserts without any process interruption.

Two types of inserts are available:

IC = KER 710 insert for one or two thermocouple sensors

IS = Sapphire insert for one or several thermocouple sensors, with the possibility of distributing the measurement points along the length of the thermowell

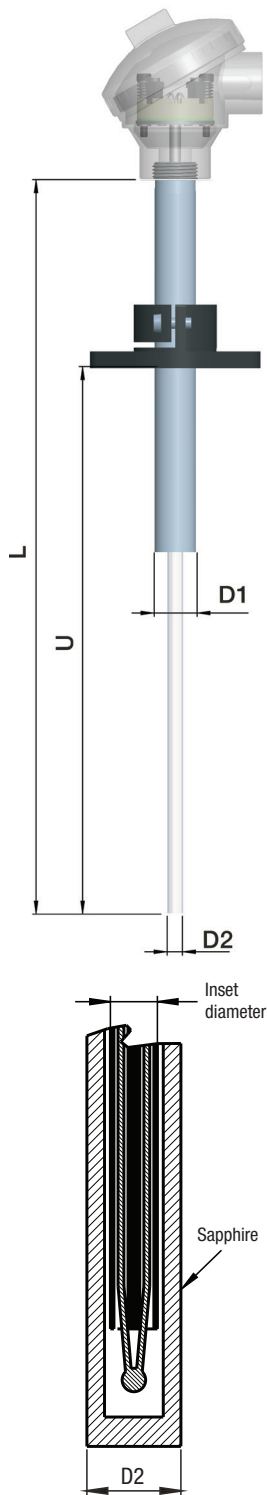

## S96 Straight or Flexible Multipoint Assemblies

### Description

These probes of multiple RTD and thermocouple sensors allow different functionalities:

- Precise process temperature for optimal conversion
- The measuring of catalyst bed inlet differential temperature to ensure proper distribution
- Indication of temperature excursions in high temperature/high pressure reactors
- Suitable for hydrocracking operations and severe hydro-treating units

### Applications

- Mounting in chemical, petrochemical and pharmaceutical reactor or vessel
- For wide range of diameters and lengths of inserts up to 1,000 ft (300 m)
- Special designs for intrinsically safe, non-incendive and explosion proof designs with FM, ATEX, and IECEx approvals

### User Industries

- Oil & Gas
- Chemical
- Power generation
- Hydrocracker
- Hydrotreating

**S96-SX**  
Straight Multipoint

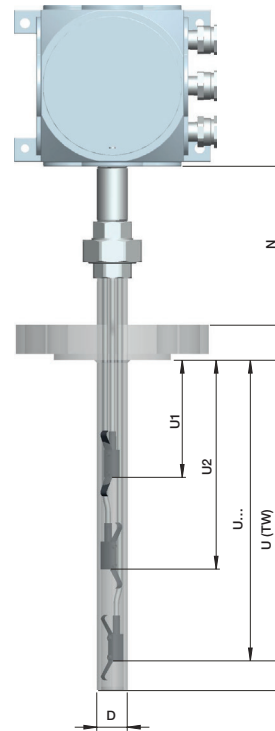

**S96-FX**  
Flexible Multipoint

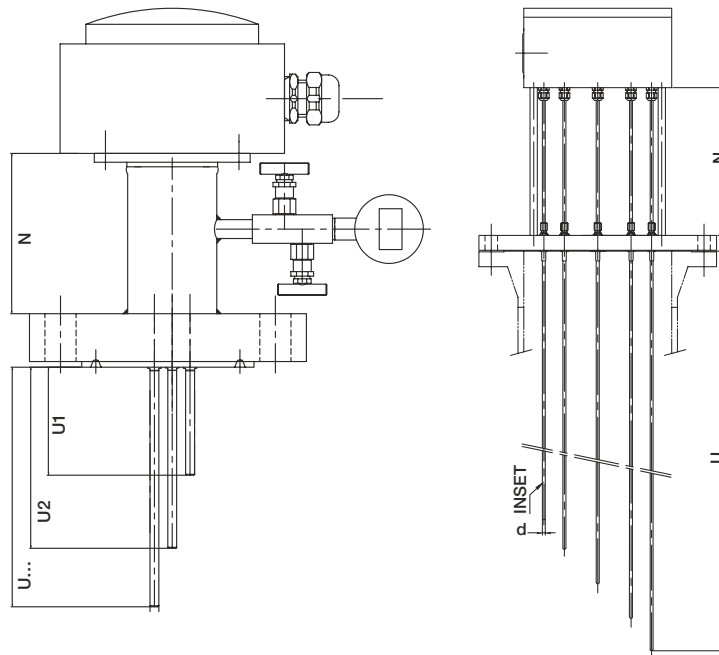

# Thermowells

## Flanged

The Ashcroft® flanged thermowell is used when pressure, high velocity and corrosive process media exist. This serves to isolate and protect the sensing instrument, and permits removal of a sensing instrument without shutting down the process. Thermowells are offered in a wide selection of materials, sizes and dimensions—a perfect solution for protecting the process and extending product service life.

### Key Features

- One piece bar stock
- Wide selection of materials
- Selection of shank styles
- Stamped with date code, material and heat numbers
- Wake frequency calculation available

### Specifications

- Raised face, flat face and ring joint versions (ASME B16.5)
- Process connection: 1, 1½ and 2 NPT
- Bore size: 0.260", 0.385"
- Flange ratings: 150, 300, 600, 900, 1,500 and 2,500 class



## Threaded

The Ashcroft® threaded thermowell is utilized when pressure, high velocity and corrosive process media exist. This serves to isolate and protect the sensing instrument, and permits removal of a sensing instrument without shutting down the process—a perfect solution for protecting the process and extending product service life.

### Key Features

- Straight, stepped or tapered designs
- One piece bar stock construction
- Wide selection of sizes, material and dimensions
- Stamped with date code, material and heat numbers
- Wake frequency calculation available

### Specifications

- Process connection: ½, ¾ and 1 NPT
- Bore size: 0.260", 0.385"



## Weld-in

The Ashcroft® weld-in thermowell isolates and protects a temperature instrument's sensing element from pressurized, high velocity and corrosive media. This is typically used where exposed threads may collect contaminants such as in food processing or pharmaceutical production. It ensures longer life and accurate measurement while allowing the sensing instrument to be removed without shutting down the process.

### Key Features

- Wide selection of materials
- Stamped with date code, material and heat numbers
- Wake frequency calculation available

### Specifications

- Process connection: 1½
- Bore size: 0.260", 0.385"



## Van Stone

The Ashcroft® Van Stone thermowell is used when pressure, high velocity and corrosive process media exist. Designed to mate between two existing flanges, it serves to isolate and protect. It also allows the sensing instrument to be removed without requiring process shut down—an ideal solution for ensuring system operation.

### Key Features

- Wide selection of materials
- Stamped with date code, material and heat numbers
- Wake frequency calculation available

### Specifications

- Fits: 1" and 1½" lap joint flanges
- Bore size: 0.260", 0.385"



# Choose Ashcroft for Your Temperature Measuring Applications

For more information talk to an Ashcroft expert to discuss your specific requirements. We will work with you to develop and define detailed sensor specification that will work in your application.

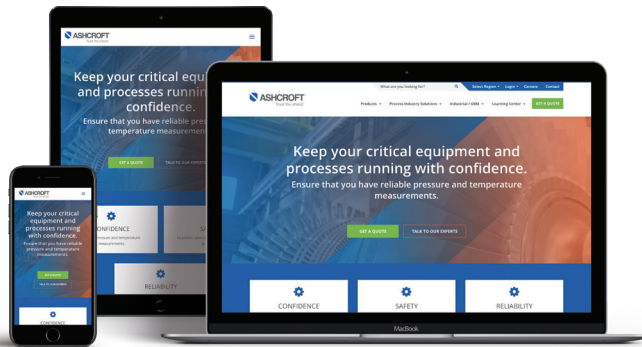

[ashcroft.com](https://www.ashcroft.com) 