

This drawing includes confidential information which is the property of ASHCROFT INC. This copy is loaned for a specific purpose, with the understanding that it will not be reproduced or used for any other purpose or disclosed to others, and it will be returned on demand.

ASHCROFT® INC.

250 EAST MAIN STREET
STRATFORD, CT 06614

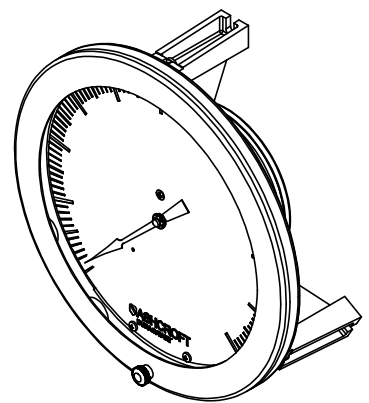
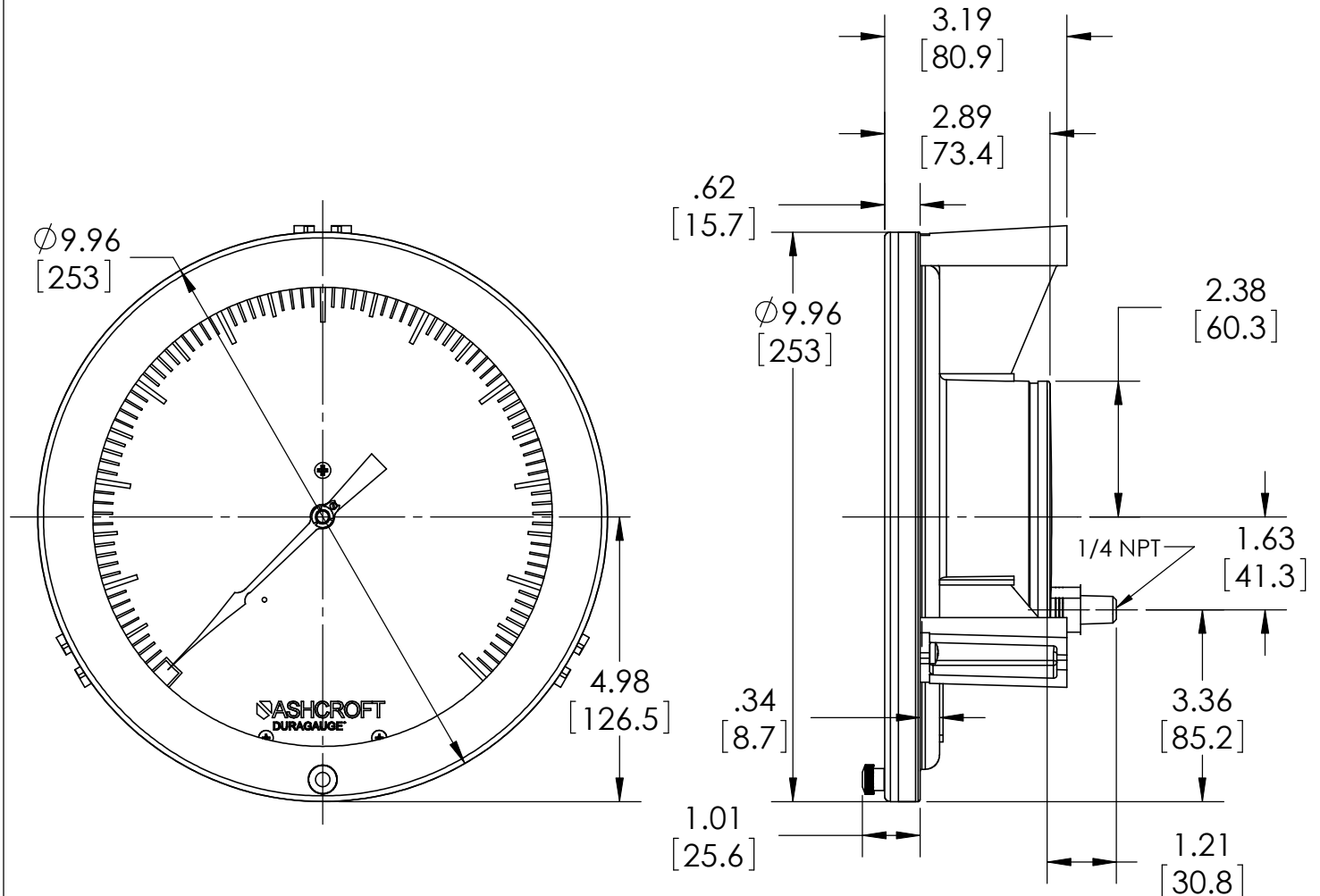

Note: 3 Mounting studs threaded equally spaced on a 9.625" [244] Bolt Circle.

DIMENSIONS IN [] ARE MILLIMETERS

REV.	ECO	DESCRIPTION	BY	DATE
A	0004455	RELEASED GENERAL DIMS. FOR 85 1377 02B XBF	MJS	6/4/2010

This print certified correct for		General Dimensions			
Customer's Name		85 1377 02B XBF SERIES			
		WALL MOUNTED DURAGAUGE			
Customer's Order No.		Drawn MJS	Date 6/4/10	Date of Issue	
Ashcroft Order No.		Checked	Date	SHEET-1	Rev.
Certified by	Date	Approved	Date	70A3048	A